

# Stirrer & Mixer



- |  |   |  |   |  |   |
|--|---|--|---|--|---|
|  | <p>Satisfaction with the requirements of European regulations and guidelines.</p>                   |  | <p>Certification of conformity of electricity, gas, etc. in accordance with the safety standards of Canada and USA.</p> |  | <p>Registered patent based on JEIO TECH's proprietary technology.</p>                                       |
|  | <p>Recognized as an excellent design product by the Ministry of Commerce, Industry, and Energy.</p> |  | <p>Compliance with Guidelines for Restriction of Hazardous Substances Use.</p>  |  | <p>More precise temperature control through temperature calibration.</p>                                    |
|  | <p>Over temperature protection function.</p>  |  | <p>Maintains possible maximum orbital motion without stopping, even if overload occurs.</p>                             |  | <p>Intuitive operation with Color Touch display.</p>  |
|  | <p>Control of temperature / humidity / rpm / time, etc. through dedicated program.</p>              |  | <p>If the surface temperature of the hot plate exceeds 50 degrees, the warning lamp turns on.</p>                       |  | <p>Possible to check and control temperature of sample by connecting to device with an external sensor.</p> |
|  | <p>Possible to set end time or start time of device operation.</p>                                  |  | <p>2 year warranty Free A/S.</p>  |  |   |

## General Application

Hotplate: Acid and base digestions, trace metal analysis, sample drying, general reagent heating, evaporation.

Hotplate Stirrer: Accurate, stable, and highly-reproducible in various heating stirring experiments.

Magnetic Stirrer: Crystallization, solvent evaporation, chemical reaction, titration, distillation, media dissolution, food processing.

Overhead Stirrer: Petrochemical sector, beverage/hot water product/dairy product production, food processing.

Vortex Mixer: Powerful mixing of solutions.

	Description	Max. Speed (rpm)	Max. Capacity (L / cuft)	Max. Temp. Range (°C / °F)	Model	Page	
Hotplate & Magnetic Stirrer	Digital	• Stable and precise control based on sample temperature	2000	20 / 0.71	350 / 662	TS	128
	Analog	• Easy to use and verified excellent durability	2000	20 / 0.71	350 / 662	TM	129
	Multi Type	• Differentiated multi-stirrer with temperature control	2000	0.25 x 15ea / 0.009 x 15ea	120 / 248	MS-MH	130
Hotplate	Digital	• Precise digital temperature control and timer function	N/A	N/A	350 / 662	T	131
Magnetic Stirrer	Digital	• Accurate and smooth control of sample viscosity changes	2000	5 / 0.18	N/A	MS-G	134
	Analog	• Fast stirring speed control with real time response	2500	5 / 0.18	N/A	MS-B MS-T	135
	Multi Type	• Optimized for diverse uses with differentiated stirring controls	2000	0.25 x 15ea / 0.009 x 15ea	N/A	MS-M	136
Overhead Stirrer	Prestige Touch	• Powerful torque motor and Color Touch Display operation	2000	100 / 3.53	N/A	MSH	144
	High Performance	• Computer connection operation and stable control function	2000	20 / 0.71	N/A	MSD	146
	Easy Control	• Optimized for easy use overheating /overload safety function	2000	20 / 0.71	N/A	MSA	147
Vortex Mixer	Touch / Continuous	• True vortex mixing in innovative touch mode	3000	N/A	N/A	VM	154

※ The contents of the above and the contents of this catalog may differ depending on the specific model and conditions of use. For the information about the features and specifications that applying to each models, please check the information on the corresponding page of each models.



## Hotplate & Magnetic Stirrer

### Safe Hotplate & Magnetic Stirrer Proven durability and useful safety features

> **Variety of products optimized for purpose of use**

15 models available depending on the size and shape of the top plate, control method, and whether stirring is present.

> **Corrosion-resistant hotplates with white ceramic coating**

The white upper hotplate, which makes it easy to observe samples, is ceramic coated and has excellent corrosion resistance. (except for MS-MH)

> **Top plate with excellent heat transfer and durability**

Excellent durability and heat transfer ability as the heater is embedded in the top plate made of aluminum. (except for MS-MH)

> **Safety with spill-proof design**

Improved safety with structural design that prevents solution from flowing into the equipment.

> **Multiple overheating protection devices**

Equipment breakdown is prevented in advance with overheating prevention device for top plate, and main parts of the inside of the body, etc.

> **BLDC motor with excellent durability**

Excellent durability even for long-term use with BLDC motor. (except for T-series)

> **Maintains stirring ability even at high temperatures**

Using special permanent magnets that maintain strong magnetic force even at high temperatures. (except for T-Series)

> **Safety function of displaying top plate overheating**

A warning is displayed when the top plate is over 50°C even when the power is switched off. (except for MS-MH)



Digital feedback control. (left)  
Analog type scale control. (right)



Top plate with excellent heat transfer.



Top plate overheating indicator light.



## Stable & Powerful Magnetic Stirrer Stable Stirring with Differentiated Controllability

- > **Variety of products optimized for purpose of use**  
20 different models provided depending on the size and shape of the top plate, control method, and color, etc.
- > **BLDC motor with excellent durability**  
Excellent durability even during long-term repeated use with BLDC motor.
- > **Special magnet for maintaining stirring ability**  
Using a special permanent magnet to maintain powerful magnetic coupling.
- > **Safety with spill-proof design**  
Improved safety with structural design that prevents solution from flowing into the equipment.
- > **Slip prevention for glassware**  
Silicone top plate cover prevents accidents caused by slipping of glassware.
- > **Top plate cover for easy sample observation**  
White and black cover provided as standard makes it very convenient to observe changes according to the sample.
- > **Fast stirring speed control with real time response**  
Quick control of stirring speed (MS-B/T model) according to adjust with the of control knobs.
- > **Smooth and precise speed control**  
Smooth stirring control up to the settings values. Accurate feedback control. (MS-G/M model)

※ Some of the above contents are limited to specific models.



Silicone cover prevents slippage of glassware.



Easy to choose from various model configurations.



Selection of white or black cover according to sample.



# Hotplate & Magnetic Stirrer

## Digital type

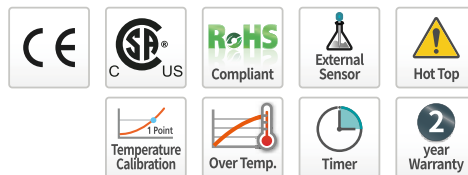

## Precise control based on sample temperature

### Structural Functional Features

- Includes temperature probe (B class) as standard.
- Displays external temperature sensor errors.
- Top plate coated with white ceramic for excellent corrosion resistance.
- Excellent heat transfer and durability due to heater-integrated structure.
- Using special permanent magnets for maintaining stirring ability.

### Use Convenience Features

- Precise temperature/stirring control with PID feedback control.
- Temperature control mode selection function. (Optimal/Fast/Slow/User/Point)
- Includes temperature auto-tuning and calibration functions.
- Count-down timer provided. (up to 99 hours and 59 minutes)
- Clamp Rod (option) can be added to the main body fix other experiment equipment.
- Convenient experiment observation with removable transparent shield. (option)

### Outstanding Safety

- Spill-proof design minimizes inflow solution into device.
- Safety ensured by BLDC motor that does not generate sparks.
- Preventing equipment failure with multiple over temperature prevention devices.
- Warning displayed when top plate is 50°C or more.
- Prevents sample run-off thanks to smooth stirring start.
- The heating bath (option) is combined with the top plate to ensure safety. (except TS-Q)



**TS-18QG**

with 3 Prong Clamp, Clamp Rod (option)



**TS-17SG**

## Specification

Model		TS-14SG	TS-17SG	TS-18QG
Heating	Temperature range (°C /°F)	Top plate, Max, 350 / 662	Top plate, Max, 350 / 662	Top plate, Max, 350 / 662
	Control mode	PID Feedback (optimal, fast, slow)	PID Feedback (optimal, fast, slow)	PID Feedback (optimal, fast, slow)
	Display resolution (°C /°F)	0.1 / 32.18	0.1 / 32.18	0.1 / 32.18
Stirring	Speed range (rpm)	30 to 2000	30 to 2000	30 to 2000
	Capacity (H <sub>2</sub> O, L)	20	20	20
	Magnetic bar, Max. (L x Ø, mm / inch)	40 x 8 / 0.31 x 1.57	40 x 8 / 0.31 x 1.57	40 x 8 / 0.31 x 1.57
Material	Top plate	White ceramic coated aluminum alloy	White ceramic coated aluminum alloy	White ceramic coated aluminum alloy
	Body	Powder coated aluminum alloy	Powder coated aluminum alloy	Powder coated aluminum alloy
	Motor type	BLDC (Brushless Direct Current)	BLDC (Brushless Direct Current)	BLDC (Brushless Direct Current)
	Temperature probe	PT 100 (B class, Max. 250°C ,482°F)	PT 100 (B class, Max. 250°C ,482°F)	PT 100 (B class, Max. 250°C ,482°F)
Dimensions	Top plate (Ø or W x D, mm / inch)	140 / 5.51	170 / 6.69	180 x 180 / 7.08 x 7.08
	Exterior (W x D x H, mm / inch)	161 x 290 x 100 / 6.34 x 11.42 x 3.94	191 x 330 x 101 / 7.52 x 12.99 x 3.98	209 x 326 x 102 / 8.22 x 12.83 x 4.0
	Net weight (kg / lbs)	2.8 / 6.17	3.5 / 7.71	3.8 / 8.36
Timer (Heating and/or Stirring)		Max. 99 hrs 59 min.	Max. 99 hrs 59 min.	Max. 99 hrs 59 min.
Electrical requirements (230V, 50/60Hz, A)		3.0	4.0	4.0
Cat. No.		<b>AAH34445K</b>	<b>AAH34475K</b>	<b>AAH34485K</b>
Electrical requirements (120V/60Hz, A)		5.0	6.7	6.7
Cat. No.		<b>AAH34443U</b>	<b>AAH34473U</b>	<b>AAH34483U</b>

※ Except TS-18Q CSA certification ※ Except TS-17S, 18Q RoHS certification.

**Accessories** Page 133 Temperature Probe, Heating Bath, Clamp Rod, Clamp, Transparent Shield

# Hotplate & Magnetic Stirrer

## Analog type

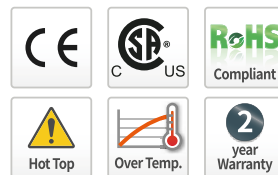

## Easy to use with excellent durability

### Structural Functional Features

- Five models provided according to the size and shape of hot plate.
- Top plate coated with white ceramic for excellent corrosion resistance.
- Excellent heat transfer and durability due to heater-integrated structure.
- Using special permanent magnets for maintaining stirring ability.

### Use Convenience Features

- Easy adjustment of heating rate and stirring speed with individual control knobs.
- Maintains a constant stirring speed even when sample viscosity changes.
- Rapid stirring and stop function according to the user's needs.
- Clamp Rod (option) can be added to the main body to fix other experiment equipment.
- Convenient experiment observation with removable transparent shield. (option)

### Outstanding Safety

- Spill-proof design minimizes inflow solution into device.
- Safety ensured by BLDC motor that does not generate sparks.
- Preventing equipment failure with multiple over temperature prevention devices.
- Warning displayed when top plate is 50°C or more.
- Prevents sample run-off thanks to smooth stirring start.
- The heating bath (option) is combined with the top plate to ensure safety. (except TM-QG)



**TM-14SG**

with Heating Bath, Clamp Holder, 3 Prong Clamp, Clamp Rod (option)



**TM-18QG**



## Specification

	Model	TM-14SG	TM-14RB	TM-17SG	TM-17RB	TM-18QG
<b>Heating</b>	Temperature range (°C / °F)	Top plate, Max, 350 / 662	Top plate, Max, 350 / 662	Top plate, Max, 350 / 662	Top plate, Max, 350 / 662	Top plate, Max, 350 / 662
	Control mode	Scale	Scale	Scale	Scale	Scale
	Heating rate	0 ~ 100% by 1%	0 ~ 100% by 1%	0 ~ 100% by 1%	0 ~ 100% by 1%	0 ~ 100% by 1%
<b>Stirring</b>	Speed range (rpm)	Max. 2000	Max. 2000	Max. 2000	Max. 2000	Max. 2000
	Capacity (L / cu ft, H <sub>2</sub> O)	20 / 0.71	20 / 0.71	20 / 0.71	20 / 0.71	20 / 0.71
	Magnetic bar, Max. (L x Ø, mm / inch)	40 x 8 / 0.31 x 1.57	40 x 8 / 0.31 x 1.57	40 x 8 / 0.31 x 1.57	40 x 8 / 0.31 x 1.57	40 x 8 / 0.31 x 1.57
<b>Material</b>	Top plate	White ceramic coated aluminum alloy	White ceramic coated aluminum alloy	White ceramic coated aluminum alloy	White ceramic coated aluminum alloy	White ceramic coated aluminum alloy
	Body	Powder coated aluminum alloy	Powder coated aluminum alloy	Powder coated aluminum alloy	Powder coated aluminum alloy	Powder coated aluminum alloy
	Motor type	BLDC (Brushless Direct Current)	BLDC (Brushless Direct Current)	BLDC (Brushless Direct Current)	BLDC (Brushless Direct Current)	BLDC (Brushless Direct Current)
<b>Dimensions</b>	Top plate (Ø or W x D, mm / inch)	140 / 5.51	140 / 5.51	170 / 6.69	170 / 6.69	180 x 180 / 7.08 x 7.08
	Exterior (W x D x H, mm / inch)	161 x 290 x 100 / 6.34 x 11.42 x 3.94	210 x 294 x 99 / 8.27 x 11.57 x 3.9	191 x 330 x 101 / 7.52 x 12.99 x 3.98	240 x 324 x 100 / 9.25 x 12.76 x 3.94	209 x 326 x 102 / 8.22 x 12.83 x 4.0
	Net weight (kg / lbs)	2.8 / 6.17	3 / 6.61	3.5 / 7.72	3.6 / 7.94	3.8 / 8.37
<b>Body Shape</b>		Straight body	Round body	Straight body	Round body	Straight body
<b>Electrical requirements (230V, 50/60Hz, A)</b>		3.0	3.0	4.0	4.0	4.0
<b>Cat. No.</b>		<b>AAH34245K</b>	<b>AAH34315K</b>	<b>AAH34275K</b>	<b>AAH34325K</b>	<b>AAH34285K</b>
<b>Electrical requirements (120V, 60Hz, A)</b>		5.0	5.0	6.7	6.7	6.7
<b>Cat. No.</b>		<b>AAH34243U</b>	<b>AAH34313U</b>	<b>AAH34273U</b>	<b>AAH34323U</b>	<b>AAH34283U</b>

※ Except TM-18QG CSA certification ※ Only TM-14SG RoHS certification.

**Accessories** [Page 133](#) Heating Bath, Clamp Rod, Clamp, Transparent Shield

# Hotplate & Magnetic Stirrer Multi type



## Differentiated multi-stirrer with temperature control

### Structural Functional Features

- Integrated design with top plate and heater for fast heat transfer and excellent durability.
- Using special permanent magnets for maintaining stirring ability.
- Control by All/Column/Row/Point with four stirring control methods and timer function.



MS-53MH

### Use Convenience Features

- Separate heater knobs and operation LED display.
- Maintains accurate speed with feedback control even when sample viscosity and amount change.
- Count-down timer provided. (up to 99 hours and 59 minutes)
- Rapid stirring and stop function according to the user's needs.
- VFD display with excellent visual perception.

### Outstanding Safety

- The upper part of the top plate is composed of silicon pads, allowing for prevention of slippage of glassware and display of stirring point.
- Spill-proof design minimizes inflow solution into device.
- Safety ensured by BLDC motor that does not generate sparks.
- Safe by automatically shutting down the heater power when overheated.
- Prevents sample run-off thanks to smooth stirring start.

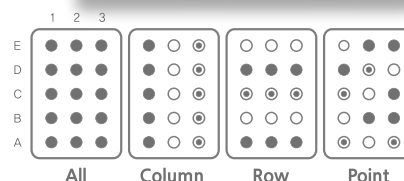

## Specification

Model		MS-33MH	MS-53MH
Heating	Temperature range (°C /°F) <sup>1)</sup>	Top plate, Max, 120 / 248	Top plate, Max, 120 / 248
	Control mode	Scale	Scale
	Heating Power (W)	600	1000
Stirring	Speed range (rpm)	30 to 2000	30 to 2000
	Capacity per point at 2,000rpm (H <sub>2</sub> O, mL / cu ft)	500 / 0.017	500 / 0.017
	Operating mode	4 (All, Column, Row, Point)	4 (All, Column, Row, Point)
	Position (Row x Column)	9 (3 x 3)	15 (5 x 3)
	Point distance (W x D, mm / inch)	117 x 90 / 4.61 x 3.54	117 x 90 / 4.61 x 3.54
	Magnetic bar , Max. (L x Ø, mm / inch)	30 x 8 / 1.18 x 0.31	30 x 8 / 1.18 x 0.31
	Load, Max (kg / lbs)	30 / 66.14	30 / 66.14
Material	Top plate	Aluminum	Aluminum
	Body	Powder coated steel	Powder coated steel
	Motor type	BLDC (Brushless Direct Current)	BLDC (Brushless Direct Current)
Dimensions	Top plate (W x D, mm / inch)	385 x 328 / 15.16 x 12.91	385 x 493 / 15.16 x 19.41
	Exterior (W x D x H, mm / inch)	395 x 450 x 104 / 15.55 x 71.72 x 4.09	395 x 614 x 104 / 15.55 x 24.17 x 4.09
	Net weight (kg / lbs)	10 / 22.05	15 / 33.06
	Timer (Stirring)	Max. 99 hrs 59 min.	Max. 99 hrs 59 min.
Electrical requirements (230V, 50/60Hz, A)		4.1	5.8
Cat. No.		AAHK34015K	AAHK34025K
Electrical requirements (120V, 60Hz, A)		8.0	11.2
Cat. No.		AAHK34013U	AAHK34023U

1) This refers to the maximum temperature of the top plate. The temperature of the actual specimen may be reduced depending on the conditions of the experiment.

Accessories [Page 133](#) Magnetic Bar, Magnetic Retriever

# Hotplate Digital type



## Precise hotplate using digital method

### Structural Functional Features

- Five models provided according to the size and shape of hot plate.
- Top plate coated with white ceramic for excellent corrosion resistance.
- Excellent heat transfer and durability due to heater-integrated structure.
- Possible to set the upper and lower limit of temperature control range.

### Use Convenience Features

- Temperature control by adjustment of heating rate.
- Temperature control mode selection function. (Optimal/Fast/Slow/User/Point)
- Includes temperature auto-tuning and calibration functions.
- Count-down timer provided. (up to 99 hours and 59 minutes)
- Clamp Rod (option) can be added to the main body to fix other experiment equipment.
- Convenient experiment observation with removable transparent shield. (option)

### Outstanding Safety

- Spill-proof design minimizes inflow solution into device.
- Preventing equipment failure with multiple over temperature prevention devices.
- Separate buttons for safe operating.
- Warning displayed when top plate is 50°C or more.
- Malfunction prevented by controller lock function.
- The heating bath (option) is combined with the top plate to ensure safety. (except T-QG)



**T-14SG**

with Clamp Holder, 3 Prong Clamp, Clamp Rod (option)



**T-18QG**



## Specification

Model		T-14SG	T-14R	T-17SG	T-17R	T-18QG
Heating	Temperature range (°C /°F)	Top plate, Max, 350 / 662	Top plate, Max, 350 / 662	Top plate, Max, 350 / 662	Top plate, Max, 350 / 662	Top plate, Max, 350 / 662
	Control mode	PID Feedback (optional, fast, slow)	PID Feedback (optional, fast, slow)	PID Feedback (optional, fast, slow)	PID Feedback (optional, fast, slow)	PID Feedback (optional, fast, slow)
	Display resolution (°C /°F)	0.1 / 32.18	0.1 / 32.18	0.1 / 32.18	0.1 / 32.18	0.1 / 32.18
Material	Top plate	White ceramic coated aluminum alloy	White ceramic coated aluminum alloy	White ceramic coated aluminum alloy	White ceramic coated aluminum alloy	White ceramic coated aluminum alloy
	Body	Powder coated aluminium alloy	Powder coated aluminium alloy	Powder coated aluminium alloy	Powder coated aluminium alloy	Powder coated aluminium alloy
Dimensions	Top plate (Ø or W x D, mm / inch)	140 / 5.51	140 / 5.51	170 / 6.69	170 / 6.69	180 x 180 / 7.09 x 7.09
	Exterior (W x D x H, mm / inch)	161 x 290 x 100 / 6.34 x 11.41 x 3.94	161 x 290 x 100 / 6.34 x 11.41 x 3.94	191 x 330 x 101 / 7.52 x 12.99 x 3.98	191 x 330 x 101 / 7.52 x 12.99 x 3.98	209 x 326 x 102 / 8.23 x 12.83 x 4.01
	Net weight (kg / lbs)	2.2 / 4.85	2.4 / 5.29	2.9 / 6.39	2.9 / 6.39	3.4 / 7.49
Timer		Max. 99 hrs 59 min.	Max. 99 hrs 59 min.	Max. 99 hrs 59 min.	Max. 99 hrs 59 min.	Max. 99 hrs 59 min.
Electrical requirements (230V, 50/60Hz, A)		3.0	3.0	4.0	4.0	4.0
Cat. No.		<b>AAH35045K</b>	<b>AAH35115K</b>	<b>AAH35075K</b>	<b>AAH35125K</b>	<b>AAH35085K</b>
Electrical requirements (120V, 60Hz, A)		5.0	5.0	6.7	6.7	6.7
Cat. No.		<b>AAH35043U</b>	<b>AAH35113U</b>	<b>AAH35073U</b>	<b>AAH35123U</b>	<b>AAH35083U</b>

※Except T-18QG CSA certification ※Only T-14SG RoHS certification

**Accessories** Page 133 Heating Bath, Clamp Rod, Clamp, Transparent Shield

Stirrer & Mixer



# Heating Block for Round Flask and Vial



## A safe solution to replace oil bath and heating mantle when heating the contents over 100°C

### Using with Hotplate

- The heating block is mounted on a hotplate or hotplate magnetic stirrer to heat safely the contents of the 25ml - 2000ml round flask and vial.
- Excellent compatibility with various brands of hotplates. (flask dia. 135/140, Vial-135/180/150 x 150/180 x 180 (mm))
- Combination of inserts (option) allows the use of flasks of various capacities.

### Excellent Safety Standards

- No risk of burns or noxious fumes due to heated oil that may occur when using an oil bath.
- Hot spots do not occur even when heated up to 300°C, resulting in excellent temperature accuracy and prevention of damage to glassware.

### Use Convenience Features

- Economical and eco-friendly by eliminating the need to purchase and dispose of oil separately.
- Since oil is not used, it is easy to clean glassware and the product.



Hard anodized surface is treated on aluminum block body, so there is no concern regarding discoloration and the durability is excellent.



Highly compatible with top plates of various heaters.



Good contacting to flask surface with excellent thermal conductivity.

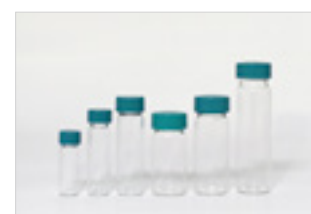

Various inserts (1 dram, 2 dram, 4 dram, 20ml, 30ml, 40ml) with vials of various capacities applicable.

## Specification

Round Flask Heating Block				Vial Heating Block			
Plate		Insert		Plate		Insert	
Model	Volume	Model	Volume	Model	Volume	Model	Volume
RBP-100	100 ml	RBI-25	25 ml	VBP	190 x 190 x 20 mm (Insert max. Four Mounted)	VBI-1D	4 ml (1 dram) (Φ 15 x 17 mm), 16 holes
		RBI-50	50 ml			VBI-2D	8 ml (2 dram) (Φ 17 x 23 mm), 16 holes
RBP-500	500 ml	RBI-100	100 ml			VBI-4D	15 ml (4 dram) (Φ 21 x 30 mm), 16 holes
		RBI-250	250 ml			VBI-20S	20 ml (Φ 28 x 22 mm), 4 holes
RBP-1000	1000 ml	RBI-500	500 ml			VBI-30S	30 ml (Φ 28 x 32 mm), 4 holes
RBP-2000	2000 ml	RBI-1000	1000 ml			VBI-40S	40 ml (Φ 28 x 42 mm), 4 holes

# Accessories for Hotplate & Magnetic Stirrer

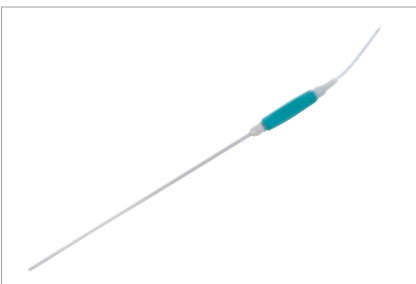

## Temperature Probe, B Class

With external temperature sensor, it is possible to check and control the temperature of the sample when it is connected to the equipment. (TS model)



## Heating Bath

Top plate combines concave and convex structure, resulting in no slippage.



## Clamp Rod

Two pieces can be fixed on the left and right of the back of the main body.



## 3 Prong Clamp

Various types of instruments can be fixed.

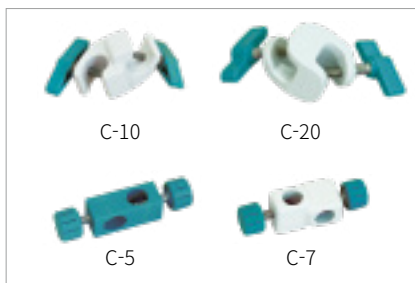

## Clamp Holder

Clamp rod and clamp can be fixed.



## Transparent Shield

Safely observe experiments.

## Magnetic Bar

- Applied to a magnetic stirrer when stirring within the temperature range up to +280°C.
- Turbo type can be applied at high temperature of 400°C.

## Accessories [Page 140](#)



## Magnetic Retriever

- Used when taking out magnetic bar.
- Uses ALNICO V magnets and samarium cobalt magnets.

## Accessories [Page 141](#)



Cat. No.	Description
AAA34501	Temperature Probe, B Class (Max. 250°C)
AAA34502	Temperature Probe, A Class (Max. 400°C)
00HPS0000012	Heating Bath (TS-14SG, TM-14SG, T-14SG)
00HPS0000015	Heating Bath (TS-17SG, TM-17SG, T-17SG)
00MTT0000132	Clamp Rod (Ø12, 400 mm)
BEA1000011	3 Prong Clamp (80 mm grip)
BEA1000012	3 Prong Clamp (60 mm grip)
BEA1000013	3 Prong Clamp (20 mm grip)
AAA37511	Clamp Holder (max. Ø27, C-20)
AAA37512	Clamp Holder (max. Ø17, C-10)
AAA37513	Clamp Holder (max. Ø12, C-7)
AAA37514	Clamp Holder (max. Ø12, C-5)
00HPS0000059	Transparent Shield (TS-14SG, TM-14SG, T-14SG)
00HPS0000039	Transparent Shield (TS-17SG, TM-17SG, T-17SG)

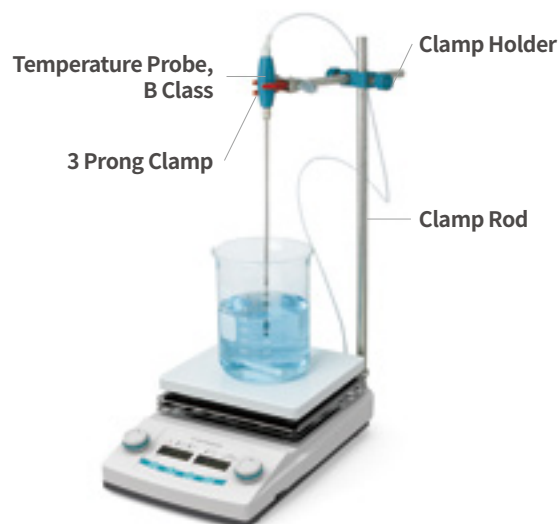

# Magnetic Stirrer

## Digital type



## Accurate and smooth feedback speed control

### Structural Functional Features

- Maintains accurate speed with feedback control even when sample viscosity and amount change.
- Polypropylene (PP) material with excellent chemical resistance.
- Minimized vibration during high-speed stirring with rubber feet.
- Use of special permanent magnets to maintain stirring performance.

### Use Convenience Features

- Simultaneous display of set speed and actual speed.
- Timer (up to 99 hours 59 minutes) and program operation function. (2-step repeat pattern)
- Clamp Rod (option) can be added to the main body to fix other equipment such as burette, sensor, etc.
- 4 models provided according to the quantity and size of stirring.
- The two types of black and white covers are very useful for observing changes according to samples.



### Outstanding Safety

- Safety ensured by BLDC motor that does not generate sparks.
- Spill-proof design minimizes inflow solution into device.
- Prevents samples splash with smooth operation at the start and stop of stirring.
- Provides silicon-based top plate cover to prevent slipping accidents of glassware.



## Specification

Model		MS-17G	MS-22G	
Stirring	Speed range (rpm)	30 to 2000	30 to 2000	
	Capacity (H <sub>2</sub> O, L)	4	5	
	Speed stability (± %)	1	1	
	Magnetic bar, Max. (L x Ø, mm / inch)	40 x 8 / 0.31 x 1.57	50 x 10 / 1.97 x 0.39	
	Load, Max. (kg / lbs)	20 / 44.09	25 / 55.12	
Material	Top plate	Polypropylene with silicone cover	Polypropylene with silicone cover	
	Body	Polypropylene	Polypropylene	
	Motor type	BLDC (Brushless Direct Current)	BLDC (Brushless Direct Current)	
Dimensions	Top plate	170 (Ø, mm) / 6.69 (inch)	220 (Ø, mm) / 8.66 (inch)	
	Exterior (W x D x H, mm / inch)	210 x 280 x 72 / 8.27 x 11.02 x 2.83	260 x 355 x 72 / 10.23 x 13.98 x 2.83	
	Net weight (kg / lbs)	1.4 / 3.09	1.8 / 3.97	
Electrical requirements		AC 100 ~ 240V, 50 / 60 Hz		
Power consumption (W)		6	6	
Cat. No.	Persian blue	KR plug	AAH331215BK	AAH331315BK
		US plug	AAH331215BU	AAH331315BU
	Orange	KR plug	AAH331215YK	AAH331315YK
		US plug	AAH331215YU	AAH331315YU

Accessories [Page 138](#) Plate Cover, Clamp Rod, Clamp Holder, Magnetic Bar, Magnetic Retriever

# Magnetic Stirrer

## Analog type



### Quick speed control of stirring with real time response

#### Structural Functional Features

- 10 models according to size, shape and color.
- Polypropylene (PP) material with excellent chemical resistance.
- Minimized vibration during high-speed stirring with rubber feet.
- Using special permanent magnets for maintaining stirring ability.

#### Use Convenience Features

- Quick control of stirring speed in real time according to degree of control knobs.
- The two types of black and white covers are very useful for observing changes according to samples.
- Convenient LED lamp for checking operation status.
- Lightweight makes handling convenient.

#### Outstanding Safety

- Safety ensured by BLDC motor that does not generate sparks.
- Spill-proof design minimizes inflow solution into device.
- Provides Silicon-based top plate cover to prevent slipping accidents of glassware.



MS-12B

MS-17B



MS-12T

MS-17T

Stirrer & Mixer

### Specification

Model		MS-12B	MS-17B	MS-22B	MS-12T	MS-17T	
Stirring	Speed range (rpm)	150 to 2500	150 to 2500	150 to 2500	150 to 2500	150 to 2500	
	Capacity (H <sub>2</sub> O, L)	2	4	5	2	4	
	Magnetic bar, Max. (L x Ø, mm)	30 x 8 / 1.18 x 0.31	40 x 8 / 1.57 x 0.31	50 x 10 / 1.97 x 0.39	30 x 8 / 1.18 x 0.31	30 x 8 / 1.18 x 0.31	
	Load, Max. (kg)	15 / 33.07	20 / 44.09	25 / 55.12	10 / 22.05	20 / 44.09	
Material	Top plate	Polypropylene with silicone cover	Polypropylene with silicone cover	Polypropylene with silicone cover	Polypropylene with silicone cover	Polypropylene with silicone cover	
	Body	Polypropylene	Polypropylene	Polypropylene	Polypropylene	Polypropylene	
	Motor type	BLDC (Brushless Direct Current)	BLDC (Brushless Direct Current)	BLDC (Brushless Direct Current)	BLDC (Brushless Direct Current)	BLDC (Brushless Direct Current)	
Dimensions	Top plate (Ø or W x D, mm / inch)	120 / 4.72	170 / 6.69	220 / 8.66	115 / 4.53	165 / 6.5	
	Exterior (W x D x H, mm / inch)	130 x 133 x 65 / 5.11 x 5.24 x 2.56	180 x 186 x 65 / 7.09 x 7.32 x 2.56	230 x 235 x 65 / 9.05 x 9.25 x 2.56	181 x 176 x 64 / 7.13 x 6.93 x 2.52	246 x 243 x 64 / 9.68 x 9.57 x 2.52	
	Net weight (kg / lbs)	0.6 / 1.32	0.9 / 1.98	1.1 / 2.42	0.6 / 1.32	0.9 / 1.98	
Electrical requirements		AC 100 ~ 240V, 50 / 60Hz with power adapter					
Power consumption (W)		5	6	6	5	6	
Cat. No.	Persian blue	KR plug	AAH330115BK	AAH330215BK	AAH330315BK	AAH333115BK	AAH333215BK
		US plug	AAH330115BU	AAH330215BU	AAH330315BU	AAH333116BU	AAH333216BU
	Orange	KR plug	AAH330115YK	AAH330215YK	AAH330315YK	AAH333115RK	AAH333215RK
		US plug	AAH330115YU	AAH330215YU	AAH330315YU	AAH333116RU	AAH333216RU

Accessories **Page 138** Plate Cover, Power Adapter, Magnetic Bar, Magnetic Retriever

# Magnetic Stirrer

## Multi Position type

### Differentiated multi-stirring control for multi-purpose use

#### Structural Functional Features

- Maintains accurate speed with feedback control even when sample viscosity and amount change.
- Display of stirring position on the upper part of the stainless steel.
- Using special permanent magnets for maintaining stirring ability.

#### Use Convenience Features

- Simultaneous display of set speed and actual speed.
- Count-down timer provided.  
(up to 99 hours and 59 minutes)
- Six models provided according to the quantity and size of stirring.

#### Outstanding Safety

- Safety ensured by BLDC motor that does not generate sparks.
- Spill-proof design minimizes inflow solution into device.
- Prevents samples splash with smooth operation at the start and stop of stirring.
- Silicon pad (option) to prevent slip-related accidents of glassware.



MS-53M

### Differentiated Multi Control

- Four kinds of stirring control methods and timer function allow for performance of various stirring experiments simultaneously.  
(MS-51M has two control methods.)
- Display LED point window for easy setting and confirmation.

#### All Mode

Simultaneous stirring with same speed.

#### Column Mode

Stirring with different speeds for each column.

#### Row Mode

Stirring with different speeds for each row.

#### Point Mode

Stirring with different speeds for each point

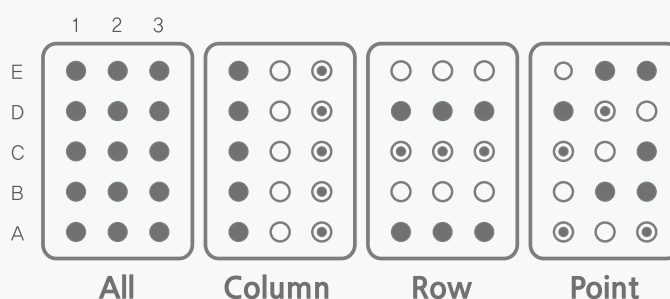



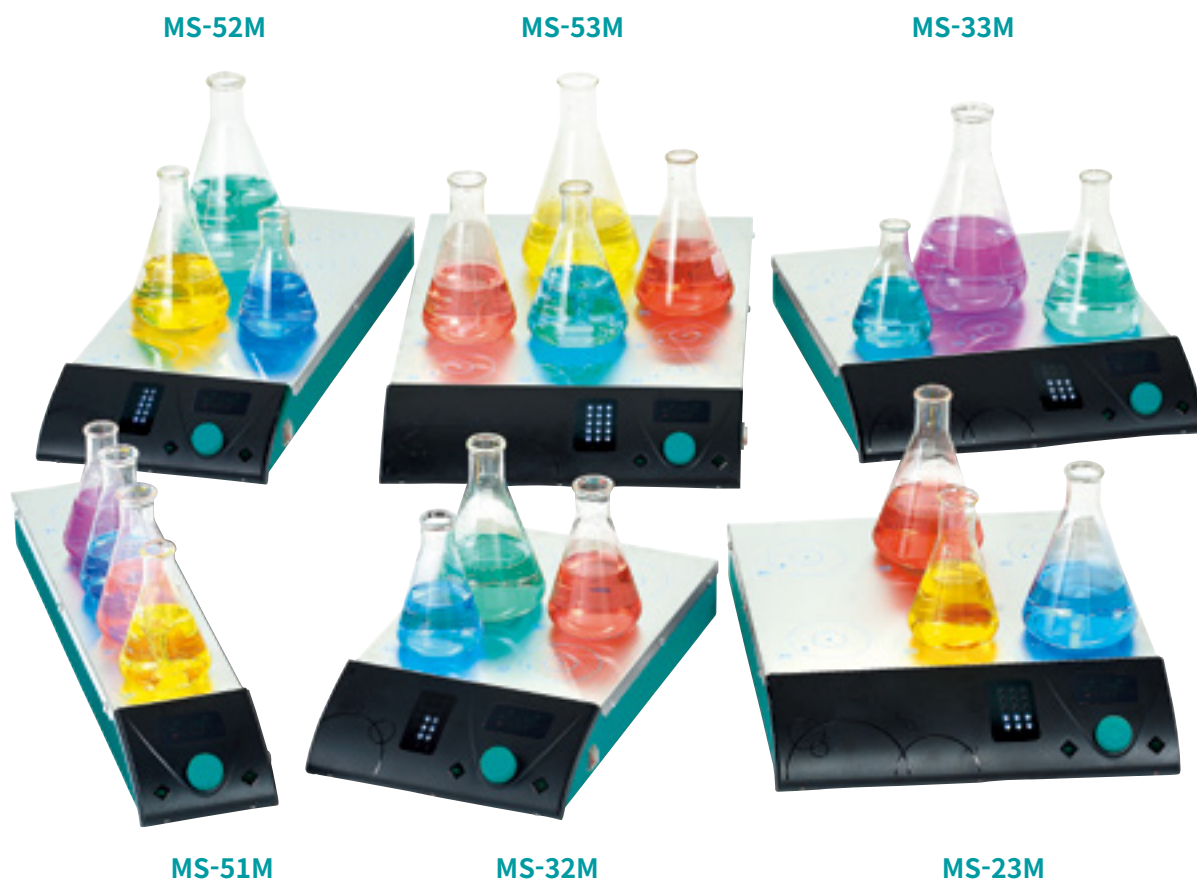

Stirrer & Mixer

## Specification

Model		MS-51M	MS-23M	MS-32M	MS-33M	MS-52M	MS-53M
<b>Stirring</b>	Speed range (rpm)	30 to 2000	30 to 2000	30 to 2000	30 to 2000	30 to 2000	30 to 2000
	Capacity per point at 2000rpm (H <sub>2</sub> O, mL)	250	250	250	250	250	250
	Operating mode	2 (All, Point)	4 (All, Column, Row, Point)	4 (All, Column, Row, Point)	4 (All, Column, Row, Point)	4 (All, Column, Row, Point)	4 (All, Column, Row, Point)
	Postion (Row x Column)	5 (5 x 1)	6 (2 x 3)	6 (3 x 2)	9 (3 x 3)	10 (5 x 2)	15 (5 x 3)
	Point distance (W x D, mm / inch)	90 / 3.54	117 x 170 / 4.61 x 6.69	117 x 90 / 4.61 x 3.54	117 x 90 / 4.61 x 3.54	117 x 90 / 4.61 x 3.54	117 x 90 / 4.61 x 3.54
	Magnetic bar , Max. (L x Ø, mm / inch)	30 x 8 / 1.18 x 0.31	30 x 8 / 1.18 x 0.31	30 x 8 / 1.18 x 0.31	30 x 8 / 1.18 x 0.31	30 x 8 / 1.18 x 0.31	30 x 8 / 1.18 x 0.31
	Load, Max. (kg / lbs)	30 / 66.14	30 / 66.14	30 / 66.14	30 / 66.14	30 / 66.14	30 / 66.14
<b>Material</b>	Top plate	Stainless steel	Stainless steel	Stainless steel	Stainless steel	Stainless steel	Stainless steel
	Body	Powder coated steel, PET	Powder coated steel, PET	Powder coated steel, PET	Powder coated steel, PET	Powder coated steel, PET	Powder coated steel, PET
	Motor type	BLDC (Brushless Direct Current)	BLDC (Brushless Direct Current)	BLDC (Brushless Direct Current)	BLDC (Brushless Direct Current)	BLDC (Brushless Direct Current)	BLDC (Brushless Direct Current)
<b>Dimensions</b>	Top plate (W x D, mm / inch)	124 x 485 / 4.88 x 19.09	362 x 318 / 14.25 x 12.52	242 x 318 / 9.53 x 12.52	362 x 318 / 14.25 x 12.52	246 x 485 / 9.68 x 19.09	367 x 485 / 14.45 x 19.09
	Exterior (W x D x H, mm / inch)	131 x 603 x 82 / 5.56 x 23.74 x 3.23	377 x 436 x 82 / 14.84 x 17.16 x 3.23	254 x 436 x 82 / 10 x 17.16 x 3.23	344 x 436 x 81 / 13.54 x 17.16 x 3.19	254 x 602 x 82 / 10 x 23.7 x 3.23	377 x 599 x 82 / 14.84 x 23.58 x 3.23
	Net weight (kg / lbs)	4 / 8.81	6 / 13.23	5 / 11.02	7 / 15.43	8 / 17.64	11 / 24.25
<b>Timer</b>	Max. 99 hrs 59 min.	Max. 99 hrs 59 min.	Max. 99 hrs 59 min.	Max. 99 hrs 59 min.	Max. 99 hrs 59 min.	Max. 99 hrs 59 min.	Max. 99 hrs 59 min.
<b>Electrical requirements</b>	AC 100 ~ 240V, 50 / 60Hz						
<b>Power consumption (W)</b>	45	45	45	54	85	135	
<b>Cat. No.</b>	<b>AAH332415K</b>	<b>AAH332115K</b>	<b>AAH332215K</b>	<b>AAH332315K</b>	<b>AAH332515K</b>	<b>AAH332615K</b>	
	<b>AAH332415U</b>	<b>AAH332115U</b>	<b>AAH332215U</b>	<b>AAH332315U</b>	<b>AAH332515U</b>	<b>AAH332615U</b>	

**Accessories** Page 138 Silicone Pad, Magnetic Bar, Magnetic Retriever

# Accessories for Magnetic Stirrer



Plate Cover (Black, White)



Silicone Pad

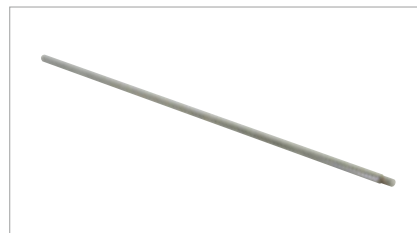

Clamp Rod

## Plate Cover

Cat. No.	Description	Model
00MTT0000002	White color, Silicone (Ø120)	MS-12B
00MTT0000003	White color, Silicone (Ø170)	MS-17B/G
00MTT0000004	White color, Silicone (Ø220)	MS-22B/G
00MTT0000005	Black color, Silicone (Ø120)	MS-12B
00MTT0000006	Black color, Silicone (Ø170)	MS-17B/G
00MTT0000007	Black color, Silicone (Ø220)	MS-22B/G
00MTT0000144	White color, Silicone	MS-12T
00MTT0000143	Black color, Silicone	MS-12T
00MTT0000146	White color, Silicone	MS-17T
00MTT0000145	Black color, Silicone	MS-17T

## Silicone Pad

Cat. No.	Description (W x D x H, mm / inch)	Model
00MTS0000015	355 x 475 x 1 / 13.98 x 18.7 x 0.04	MS-53M
00MTS0000016	235 x 475 x 1 / 9.25 x 18.7 x 0.04	MS-52M
00MTS0000017	115 x 475 x 1 / 4.53 x 18.7 x 0.04	MS-51M
00MTS0000041	235 x 310 x 1 / 9.25 x 12.2 x 0.04	MS-32M
00MTS0000042	355 x 310 x 1 / 13.98 x 12.2 x 0.04	MS-23M / 33M

## Power Adapter & Clamp Rod

Cat. No.	Description	Model
00MTT0000001	Power Adapter (100~240V, 50/60Hz)	MS-12B/17B
		MS-12T/17T
00MTT0000132	Clamp Rod (Ø12 x 400 / Ø0.47 x 15.75", M10)	MS-17G/22G

## Clamp Holder



- Up to Ø27 mm rods mountable.
- Manufactured using aluminum die-casting and plastic for lightweight but strong fixation.
- Knob structure that is comfortable to handle when locking / unlocking.
- The contact surface with the stand support is stable and does not slip.
- C-20 and C-10 models are suitable for the overhead stirrer.
- The C-10, C-7 and C-5 models are suitable for use with hotplate and magnetic stirrer.

Model	C-20	C-10	C-7	C-5
Max. Ø (mm / inch)	27 / 1.06	17 / 0.66	12 / 0.47	12 / 0.47
Open Ø (mm / inch)	20 / 0.79	15 / 0.59	-	-
Body material	Aluminum	Aluminum	Aluminum	Polypropylene
Knob material	Polypropylene	Polypropylene	Polypropylene	Polypropylene
Bolt material	Stainless Steel	Stainless Steel	Stainless Steel	Stainless Steel
Suitable for	Overhead Stirrer	Overhead Stirrer	-	-
	-	Hotplate & Magnetic Stirrer	Hotplate & Magnetic Stirrer	Hotplate & Magnetic Stirrer
Cat. No.	AAA37511	AAA37512	AAA37513	AAA37514

# Accessories Power Divider

## Clear arrangement the power supply lines of a lot of small appliance

- **Simultaneously Provides Power Up To 5 Devices**

- Simultaneously supplies DC 12V power of up to 0.7A per device for 5 devices in each channel.

- **LED lamp displaying operation state for each of 5 channels**

- Green light indicates normal operation.
- Red light indicates over-current.

- **Convenient and safe structure and functions**

- Rod supplied to fix on stand.
- Excellent durability with moisture-proof structure.
- Rubber stopper for each channel.
- Built-in over current protection function.



Stirrer & Mixer

### Specification

Model	PD-5
<b>Input</b>	DC 12V, Min. 3.5A
<b>Output</b>	DC 12V, Max. 0.7A per channel
<b>Dimension (W x D x H, mm / inch)</b>	126 x 78 x 33 / 4.96 x 3.07 x 1.3
<b>Weight (kg / lbs)</b>	0.16 / 0.35
<b>Cat. No.</b>	<b>AAH33501</b>



Application model: MS-17T, MS-12B, MS-17B

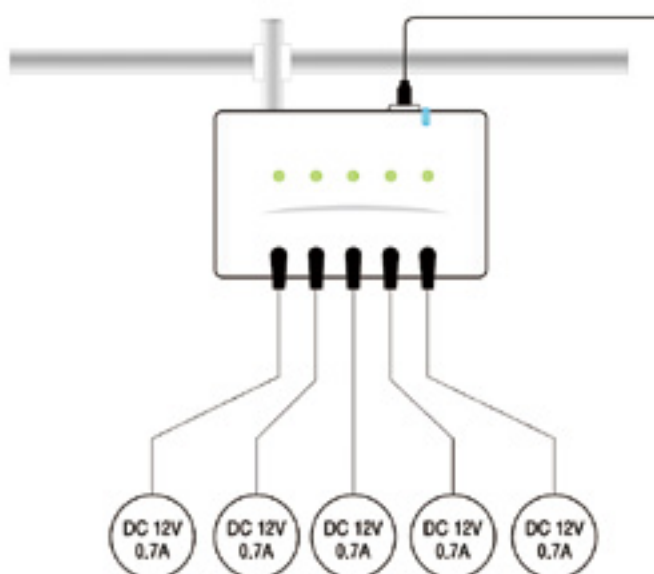

# Accessories Magnetic Bar

## Features of Magnetic Bar

- Chemically stable with PTFE inert material.
- Completely sealed structure with no cracks or pores.
- Smooth finish to avoid absorption or cross contamination.
- Working Temperature Range: up to +280°C.
- Can be sterilized using chemical or physical (thermal) methods. (except  $\gamma$  Radiation)
- Magnet-ALNICOV, PTFE Coated.

※ The size of the magnetic bar is the average value, and there may be an error of  $\pm 5\%$  in length and  $\pm 10\%$  in diameter.



## Cylindrical Magnetic Bar

- Smooth and round shape.
- The most commonly used magnetic bar for a variety of applications.

Cat. No.	D (mm / inch)	L (mm / inch)
BCW0011138	8 / 0.31	13 / 0.51
BCW0011156	6 / 0.23	15 / 0.59
BCW0011208	8 / 0.31	20 / 0.78
BCW0011258	8 / 0.31	25 / 0.98
BCW0011308	8 / 0.31	30 / 1.18
BCW001140	8 / 0.31	40 / 1.57
BCW001150	8 / 0.31	50 / 1.96

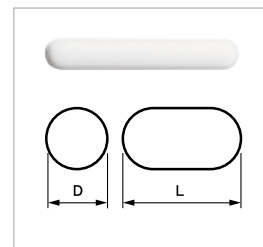

## Octahedral Magnetic Bar

- Octagonal design for more efficient sample mixing.
- Used in containers having slight slopes or uneven surfaces.
- The center of the pivot ring selects the best position for stirring.
- Bigger turbulence than pivot ring is generated at lower speeds.
- Pivot ring reduces friction and noise.

Cat. No.	D (mm / inch)	L (mm / inch)
BCW001513	8 / 0.31	13 / 0.51
BCW001515	8 / 0.31	15 / 0.59
BCW001522	8 / 0.31	22 / 0.86
BCW001525	8 / 0.31	25 / 0.98
BCW001528	8 / 0.31	28 / 0.10
BCW001538	8 / 0.31	38 / 1.49
BCW001541	8 / 0.31	41 / 1.61
BCW001551	8 / 0.31	51 / 2.00
BCW00155110	10 / 0.39	51 / 2.00

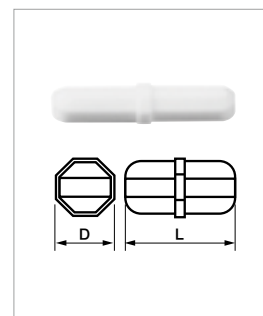

## Oval Magnetic Bar

- Designed to fit round-bottom flasks, the bar itself has a central axis.

Cat. No.	D (mm / inch)	L (mm / inch)
BCW001610	5 / 0.19	10 / 0.39
BCW001615	6 / 0.23	15 / 0.59
BCW001620	10 / 0.39	20 / 0.78
BCW00162510	10 / 0.39	25 / 0.98
BCW001630	16 / 0.63	30 / 1.18
BCW001635	16 / 0.63	35 / 1.38
BCW001640	20 / 0.78	40 / 1.57
BCW001650	20 / 0.78	50 / 1.96

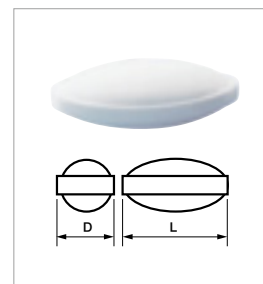

# Accessories Magnetic Retriever

## Polypropylene

- Product with built-in ALNICO V magnet and coated with polypropylene.
- Convenient structure having ring part at the end for hanging after use.

## PTFE

- Product with built-in ALNICO V magnet and coated with PTFE. (teflon)

Cat. No.	Ø (mm / inch)	L (mm / inch)	Description
BCW0041300	10 / 0.39	300 / 11.81	Polypropylene, Alnico V
BCW0041350	10 / 0.39	350 / 13.77	
BCW0041450	10 / 0.39	450 / 17.71	
BCW004150	10 / 0.39	150 / 5.90	PTFE, Alnico V
BCW004250	10 / 0.39	250 / 9.84	
BCW004350	10 / 0.39	350 / 13.77	
BCW004450	10 / 0.39	450 / 17.71	



Polypropylene



PTFE







## Overhead Stirrer

Possesses practical functions required in actual experiments, and has a beneficial and convenient configuration system

- > **Safe, spark-free motor**  
Use of spark-free BLDC motor for safer experimental environment.
- > **Reliable control technology**  
Real-time PID feedback control method maintains accurate rpm even when sample viscosity changes.
- > **Excellent structure for long-term continuous use**  
Excellent durability of BLDC motor and structure allows for powerful and excellent heat dissipation.
- > **Patented best effort performance of superior level**  
Automatic rpm control in case overload operation. Attempt to stir with set rpm according to viscosity change.
- > **Over-temperature and overload protection**  
Built-in over-temperature and overload protection device with safety functions for continuous operation of the equipment.
- > **Free selection of rotation direction**  
Rotation direction is selectable for various impeller uses. (except for MSA)
- > **Computer interface control**  
Convenient remote control and data management through provided dedicated software. (except MSA)
- > **Comfortable use with smooth stirring start**  
Progressively and smoothly reaches the set rpm, preventing accidents such as sample spill-out.



Convenient remote control and data management through dedicated software.



Dedicated software provided as standard.



Free selection of rotation direction.



## Optimized model configuration and performance Lab Companion's Overhead Stirrer

### > Model configuration for the appropriate choice

Four models provided for optimum selection according to torque, rpm, function, and display.

### > Prestige touch model (MSH)

Color touch screen and control  
Knob control via external controller. (option)

### > High performance model (MSD)

Clear FND & control knob.  
Control via PC using USB connection.

### > Easy control model (MSA)

Clear FND and control knob.  
Over temperature and overload protection functions included.

### > Slim & compact design

Design that minimizes interference with other devices even in the case of a complex set of experiments.

### > Pass-through shaft design

Impeller shaft structure can be passed through, making it easy to control the height of the impeller at the time of experiment configuration.

### > Easy to use with intuitive operation

Simple and intuitive operation environment.  
Useful function of displaying device information.

### > Controller lock to prevent erroneous operation

Controller lock to prevent errors caused by unexpected pressing of buttons. (except for MSA)

※ Some of the above contents are limited to specific models.



Model configuration according to torque, rpm, function, and display part.



Structure allows for convenient adjustment of impeller height.



Separate external controller for remote control.

# Overhead Stirrer

## Prestige touch type

### Prestige touch model with highest performance and stability

#### Structural Functional Features

- Possible for user to select clockwise (CW) / counter clock wise. (CCW)
- Slim & compact design.
- Convenient adjustment of height with pass-through impeller shaft.
- Chuck with excellent corrosion resistance. (max. Ø10 mm)
- 2 models provided according to torque and rpm.

#### Use Convenience Features

- Best effort function to maintain maximum set rpm by monitoring sample viscosity changes in real time. (application 10-2014-0124899)
- Accurate stirring with PID feedback control.
- Count-down timer provided. (up to 99 hours and 59 minutes)
- Operating elapsed time display function.
- Machine operation and data management with USB connection.
- Complete with accessories such as impeller, stand, clamp, etc.

#### Outstanding Safety

- Safety ensured by BLDC motor that does not generate sparks.
- Excellent heat dissipation structure makes use for a long time without any trouble.
- Continual use in safe by over temperature and overload protection.
- Malfunction prevented by controller lock function.
- Prevents sample run-off by smooth stirring start and stop function.
- Motor protection by displaying motor temperature in three colors.



MSH-0512

#### Easy and convenient color touch LCD controller

- Intuitive operation with touch LCD controller and control knobs.
- Displays set value, actual value, time, torque, and motor temperature.

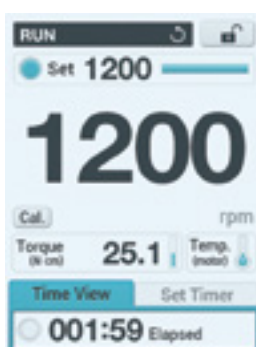

#### PC control and data management with USB connection

- Useful for data management through PC control.
- Dedicated software and USB cable provided as standard.





## Specialized External Controller

- When harmful fumes are generated through stirring, the reaction proceeds inside the fume hood and the device is safely controlled by external controller at outside.
- Checking control status in real time and controls start/stop or stirring speed changes.
- Color LCD display for intuitive and easy control.



Model	RMS
Exterior (W x D x H, mm / inch)	60 x 16 x 120 / 2.4 x 0.6 x 4.7
Wire length (mm / inch)	3000 / 118
Cat. No.	AAA37591



## Lab Companion's Bluetooth for Mobile Use

- Connects wirelessly using smartphone or tablet PC with Bluetooth enabled and a mobile app.
- Checking control status in real time and controls start/stop or stirring speed changes.
- Automatic remote notification function in case of device failure during experiment.

Model	JBT
Exterior (W x D x H, mm / inch)	140 x 54 x 18 / 5.5 x 2.1 x 0.7
Weight (kg / lbs)	0.04 / 0.09
Frequency	2.4GHz ISM band
Cat. No.	AAAQ1012



## Specification

Model	MSH-0512	MSH-0520
Speed range (rpm)	50 to 1200	50 to 2000
Viscosity, max. (cP) <sup>1)</sup>	30000 (~1200rpm) 50000 (~700rpm)	5000 (~2000rpm) 10000 (~1600rpm) 30000 (~600rpm) 50000 (~300rpm)
Stirring capacity (H <sub>2</sub> O), max. (L / cu ft)	100 / 3.53 (~1200rpm)	60 / 2.12 (~2000rpm)
Rated torque (N,cm / inch)	41.6 / 16.38	20.8 / 8.19
Motor input / output (W)	71 / 48	71 / 48
Speed control	PID feedback control	PID feedback control
Material	Body	Powder coated aluminum
	Cover	Polypropylene
	Motor type	BLDC (Brushless Direct Current)
Dimension	Chuck range (∅, mm / inch)	3~10 / 0.12~0.39
	Exterior (W x D x H, mm / inch)	80 x 185 x 235 / 3.15 x 7.28 x 9.25
	Net weight (kg / lbs)	3.1 / 6.83
Electrical requirements	AC 100 to 240V, 50/60Hz with power adapter	
Power consumption (A)	1.5	1.5
Cat. No.	KR plug	AAH371415K
	US plug	AAH371415U
		AAH371515K
		AAH371515U

1) Tested with silicone oil at 26°C and 60% RH, and uses triple-bladed propeller impeller (∅50).

Accessories [Page 148](#) Impeller, Stand & Support, Clamp, Magnetic Drive, Stirring Seals

# Overhead Stirrer

## High performance type



## High performance model for faithful advanced features and safety

### Structural Functional Features

- Possible for user to select clockwise (CW) / counter clock wise. (CCW)
- Slim & compact design.
- Convenient adjustment of height with pass-through impeller shaft.
- Chuck with excellent corrosion resistance. (max. Ø10 mm)

### Use Convenience Features

- Best effort function to maintain maximum set rpm by monitoring sample viscosity changes in real time.
- Accurate stirring with PID feedback control.
- Operating elapsed time display function.
- Machine operation and data management with USB connection.
- Complete with accessories such as impeller, stand, clamp, etc.

### Outstanding Safety

- Safety ensured by BLDC motor that does not generate sparks.
- Excellent heat dissipation structure makes use for a long time without any trouble.
- Continual use in safe by over temperature and overload protection.
- Malfunction prevented by controller lock function.
- Prevents sample run-off by smooth stirring start and stop function.



MSD-0420

## Specification

Model		MSD-0420
<b>Speed range (rpm)</b>		80 to 2000
<b>Viscosity, max. (cP)<sup>1)</sup></b>		5000 (~2000rpm) 10000 (~1200rpm) 30000 (~ 300rpm) 50000 (~ 200rpm)
<b>Stirring capacity (H<sub>2</sub>O), max. (L / cu ft)</b>		20 / 0.71 (~2000rpm)
<b>Rated torque (N,cm / inch)</b>		19 / 7.48
<b>Motor input / output (W)</b>		70 / 40
<b>Speed control</b>		PID feedback control
<b>Material</b>	Body	Powder coated aluminum
	Cover	Polypropylene
	Motor type	BLDC (Brushless Direct Current)
<b>Dimension</b>	Chuck range (Ø, mm / inch)	3~10 / 0.12~0.39
	Exterior (W x D x H, mm / inch)	75 x 215 x 150 / 2.95 x 8.46 x 5.9
	Net weight (kg / lbs)	2.8 / 6.17
<b>Electrical requirements (230V, 50/60Hz, A)</b>		0.5
<b>Cat. No.</b>		AAH373225K
<b>Electrical requirements (120V/60Hz, A)</b>		0.5
<b>Cat. No.</b>		AAH373225U

1) Tested with silicone oil at 26°C and 60% RH, and uses triple-bladed propeller impeller (Ø50).

**Accessories** Page 148 Impeller, Stand & Support, Clamp, Magnetic Drive, Stirring Seals



# Overhead Stirrer

## Easy control type



### Easy control model optimized for simple use

#### Structural Functional Features

- Excellent durability BLDC motor and dedicated controller.
- Slim & compact design.
- Convenient adjustment of height with pass-through impeller shaft.
- Chuck with excellent corrosion resistance. (max. Ø10 mm)

#### Use Convenience Features

- Accurate stirring with PID feedback control.
- Easy operating for convenient use.
- Displays the set speed and the current speed at the same time.
- Pause buttons make it easier to observe experiments.
- Motor output detection and display.
- Complete with accessories such as impeller, stand, clamp, etc.

#### Outstanding Safety

- Safety ensured by BLDC motor that does not generate sparks.
- Excellent heat dissipation structure makes use for a long time without any trouble.
- Continual use in safe by over temperature and overload protection.
- Over temperature/overload warning notification displayed.
- Prevents sample run-off by smooth stirring start and stop function.



MSA-0420

Stirrer & Mixer

### Specification

Model		MSA-0420
<b>Speed range (rpm)</b>		80 to 2000
<b>Viscosity, max. (cP) <sup>1)</sup></b>		5000 (~2000rpm) 10000 (~1200rpm) 30000 (~ 300rpm) 50000 (~ 200rpm)
<b>Stirring capacity (H<sub>2</sub>O), max. (L / cu ft)</b>		20 / 0.71 (~2000rpm)
<b>Rated torque (N,cm)</b>		19 / 7.48
<b>Motor input / output (W)</b>		70 / 40
<b>Speed control</b>		PID feedback control
<b>Material</b>	Body	Powder coated aluminum
	Cover	Polypropylene
	Motor type	BLDC (Brushless Direct Current)
<b>Dimension</b>	Chuck range (Ø, mm)	3~10 / 0.12~0.39
	Exterior (W x D x H, mm / inch)	75 x 215 x 150 / 2.95 x 8.46 x 5.9
	Net weight (kg / lbs)	2.8 / 6.17
<b>Electrical requirements (230V, 50/60Hz, A)</b>		0.5
<b>Cat. No.</b>		AAH373325K
<b>Electrical requirements (120V/60Hz, A)</b>		0.5
<b>Cat. No.</b>		AAH373325U

1) Tested with silicone oil at 26°C and 60% RH, and uses triple-bladed propeller impeller (Ø50).

**Accessories** Page 148 Impeller, Stand & Support, Clamp, Magnetic Drive, Stirring Seals

# Accessories Impeller

## Stainless steel impellers

### Propeller Impeller

- Suitable for high-speed stirring of low/medium viscosity solutions.
- Excellent mixing properties for homogeneous and suspended solids.
- it can be mounted on an overhead stirrer that rotates clockwise.

#### 3-Bladed

(Unit: mm / inch)

Cat. No.	Blade Ø	Shaft Ø	Length
AAA37521	50 / 1.97	8 / 0.31	400 / 15.75
AAA37522	70 / 2.76	8 / 0.31	400 / 15.75
AAA37523	100 / 3.94	8 / 0.31	400 / 15.75



#### 4-Bladed

(Unit: mm / inch)

Cat. No.	Blade Ø	Shaft Ø	Length
AAA37531	50 / 1.97	8 / 0.31	400 / 15.75
AAA37532	70 / 2.76	8 / 0.31	400 / 15.75
AAA37533	100 / 3.94	8 / 0.31	400 / 15.75



### Anchor Impeller

- Suitable for low-speed stirring or reaction of medium/high viscosity solutions.
- Used for polymer reactions or dispersion of large amounts of liquid minerals, etc.
- Select and use an impeller having similar size with the diameter of vessels.

(Unit: mm / inch)

Cat. No.	Blade, W x H	Shaft Ø	Length
AAA37571	45 x 45 / 1.77 x 1.77	8 / 0.31	300 / 11.81
AAA37572	60 x 60 / 2.36 x 2.36	8 / 0.31	500 / 19.69



### Paddle Impeller

- Suitable for high-speed stirring of low/medium viscosity solutions.
- Provides smooth flow during heat exchange.

(Unit: mm / inch)

Cat. No.	Blade, W x H	Shaft Ø	Length
AAA37581	70 x 70 / 2.76 x 2.76	8 / 0.31	500 / 19.69

### Dissolver Impeller

- Suitable for high/medium-speed stirring of / low/medium (<500 mPas) viscosity solutions.

(Unit: mm / inch)

Cat. No.	Blade Ø	Shaft Ø	Length
BEA0570031	55 / 2.17	8 / 0.31	350 / 13.78
BEA0570032	75 / 2.95	8 / 0.31	350 / 13.78



### Turbine Impeller

- Suitable for high-speed stirring of medium/high viscosity solutions.

(Unit: mm / inch)

Cat. No.	Blade Ø	Shaft Ø	Length
AAA37561	57 / 2.24	8 / 0.31	500 / 19.69
AAA37562	90 / 3.54	8 / 0.31	500 / 19.69



### Half-Moon Impeller

- Suitable for stirring medium viscosity solutions
- The blades are folded for use in narrow containers.
- The blades are spread by centrifugal force during stirring.

(Unit: mm / inch)

Cat. No.	Blade, W x H	Shaft Ø	Length
AAA37541	65 x 20 / 2.6 x 0.79	8 / 0.31	400 / 15.75
AAA37542	90 x 25 / 3.54 x 0.98	8 / 0.31	400 / 15.75



### Centrifugal Impeller

- Suitable for high-speed stirring of low/medium viscosity solutions.
- The blades are folded for use in narrow containers.
- The blades are spread by centrifugal force during stirring.

(Unit: mm / inch)

Cat. No.	Blade, W x H	Shaft Ø	Length
AAA37551	90 x 15 / 3.54 x 0.59	8 / 0.31	500 / 19.69
AAA37552	150 x 15 / 5.9 x 0.59	8 / 0.31	500 / 19.69



## PTFE coated impellers

### 4-Bladed propeller

(Unit: mm / inch)

Cat. No.	Blade, W x H	Shaft Ø	Length
BEA0570081	50 / 1.97	8 / 0.31	500 / 19.69
BEA0570082	70 / 2.76	8 / 0.31	500 / 19.69



Propeller (4-bladed) / Turbine

### Turbine

(Unit: mm / inch)

Cat. No.	Blade, W x H	Shaft Ø	Length
BEA0570131	70 / 2.76	8 / 0.31	500 / 19.69



Half-moon / Centrifugal

### Half-moon

(Unit: mm / inch)

Cat. No.	Blade, W x H	Shaft Ø	Length
BEA0570091	60 x 18 / 2.36 x 0.71	8 / 0.31	500 / 19.69

### Centrifugal

(Unit: mm / inch)

Cat. No.	Blade, W x H	Shaft Ø	Length
BEA0570101	76 x 17 / 2.99 x 0.67	8 / 0.31	500 / 19.69



Anchor (Square / Round)

### Anchor (Square<sup>1)</sup> / Round<sup>2)</sup>

(Unit: mm / inch)

Cat. No.	Blade, W x H	Shaft Ø	Length
BEA0570111 <sup>1)</sup>	80 x 50 / 3.15 x 1.97	8 / 0.31	500 / 19.69
BEA0570121 <sup>2)</sup>	80 x 40 / 3.15 x 1.57	8 / 0.31	500 / 19.69

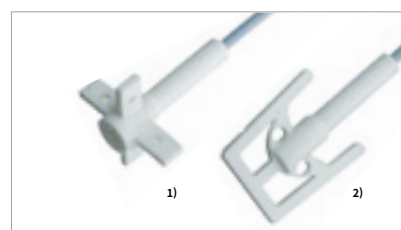

Paddle / Paddle A

### Paddle (Paddle<sup>1)</sup> / Paddle A<sup>2)</sup>

(Unit: mm / inch)

Cat. No.	Blade, W x H	Shaft Ø	Length
BEA0570141 <sup>1)</sup>	70 / 2.76	8 / 0.31	500 / 19.69
BEA0570151 <sup>2)</sup>	78 x 80 / 3.07 x 3.15	8 / 0.31	500 / 19.69

# Accessories for Overhead Stirrer

## Stand & Support



### Easy-to-use Dial Stand

- Fine adjustment of position up, down, back and forth.
- Possible to lock after finishing fine adjustment using dials.
- The structure allows for no additional clamp holder to be used.

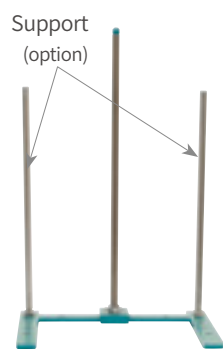

Basic Stand 1



Basic Stand 2



Basic Stand 3

### Stand

Cat. No.	Description (W x D x H, mm / inch)
AAA37501	Dial stand (400 x 400 x 700 / 15.75 x 15.75 x 27.56)
AAA37502	Basic stand 1 (400 x 400 x 700 / 15.75 x 15.75 x 27.56)
AAA37503	Basic stand 2 (300 x 400 x 700 / 11.81 x 15.75 x 27.56)
AAA37504	Basic stand 3 (250 x 350 x 700 / 9.84 x 13.78 x 27.56)

### Support

Cat. No.	Description (Ø x L, mm / inch)
00MSS0000051	Support Rod, M14 (Ø15 x 500mm / Ø0.59 x 19.68)
00MSS0000052	Support Rod, M14 (Ø18 x 500mm / Ø0.71 x 19.68)
00MSS0000053	Support Rod, M14 (Ø20 x 500mm / Ø0.79 x 19.68)

## Clamp & Seal

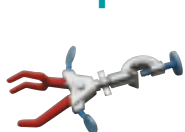

Utility Clamp 3 Prong



Utility Clamp Plat



3 Prong Clamp



2 Prong Clamp



Fixing Clamp



Flexible Coupling



PTFE Stirring seal

Cat. No.	Description
BEA1000001	Utility clamp 3 prong
BEA1000002	Utility clamp plat
BEA1000011	3 Prong clamp (80 mm grip)
BEA1000012	3 Prong clamp (60 mm grip)
BEA1000013	3 Prong clamp (20 mm grip)
BEA1000014	2 Prong clamp (60 mm grip)
BEA0570181	Fixing clamp
BEA0570191	Flexible coupling
BEA0570161	PTFE stirring seals (24/40) with 8mm hole
BEA0570162	PTFE stirring seals (29/42) with 8mm hole
BEA0570163	PTFE stirring seals (34/45) with 8mm hole

### Clamp Holder Page 138



C-20



C-10

- Made of aluminum die casting for light weight but strong fixing.
- Knob structure that is comfortable to handle when locking / unlocking.
- The contact surface with the stand support is stable and does not slip.
- C-20 and C-10 models are suitable for the overhead stirrer.

## Magnetic Drive



MD-T6



- Mixing reaction samples in case pressurized or depressurized in container, processing of resin solvents, decomposition and synthesis using enzymes, and uniform mixing of liquid raw materials.
- Experiments that require large stirring force while maintaining full sealing.
- Connected with overhead stirrer.

- The outer magnet and inner magnet are rare-earth element, which form a strong magnetic force to achieve high torque. (rotational force)
- Low vibration and high speed rotation even in a sealed state.
- Includes cooling line base for easy connection with external cooling device. (for experiments over 70°C)
- The connection point to the ground joint of glassware is easy to separate from glassware in a sealed state.

## Specification

Model		MD-T6-24	MD-T6-29	MD-T6-35
Material	Body	STS316 / Cr-Plate	STS316 / Cr-Plate	STS316 / Cr-Plate
	Bushing & seal	PTFE & viton	PTFE & viton	PTFE & viton
Max. torque (kgf.cm)		6	6	6
Driving	Pressure	1 x 10 <sup>-4</sup> mmHg to 5kg/cm <sup>2</sup>	1 x 10 <sup>-4</sup> mmHg to 5kg/cm <sup>2</sup>	1 x 10 <sup>-4</sup> mmHg to 5kg/cm <sup>2</sup>
	Temp. (with cooling)	Max. 300°C / 572°F	Max. 300°C / 572°F	Max. 300°C / 572°F
Shaft size (Ø x H, mm / inch)		8 x 209 / 0.31 x 8.23	8 x 209 / 0.31 x 8.23	8 x 209 / 0.31 x 8.23
Ground joint		24 / 40	29 / 42	34 / 45
Application		Glassware	Glassware	Glassware
Cat. No.		BEA511001	BEA511002	BEA511003





## Vortex Mixer

### More convenient and useful functions Vortex Mixer Developed with Lab Companion's Proprietary Technology

> **Touch vortex function maximizes convenience**

No matter where you touch the top of the platform, it's very easy to use with fast vortex formation.

> **Patented touch switch method**

Stable and sensitive Touch vortex using touch switch connected to top plate.  
(patent registered: 10-1678161)

> **Low height to minimize burden on the wrist**

The structure minimizes the burden on the wrist during repeated use due to its low height.

> **Structure to maintain stability at high speeds**

The low-profile design and rubber feet make for slip-free operation of the equipment.

> **Multiple tubes can be combined simultaneously**

Multiple vortex tubes can be used simultaneously to reduce the required time for efficient testing.

> **Offers use environment of diverse tube shapes and capacities**

Most tubes such as centrifuge tubes, conical tubes, and test tubes can be used in Touch mode.

> **Powerful and fast vortex formation**

Runs up to 3,000 rpm for reliable and strong sample mixing.

> **Proven structural excellence**

BLDC motor with excellent durability.  
Structure allows for low noise and low vibration even at 3,000rpm.



Rapid vortex formation even touching anywhere on top plate.



Available to handle the several tubes at the same time.



Available in various shapes.



## Diverse vortex mixing in one device with optimized configuration can be used for various experiments

- > **Variety of convenient accessories**  
Tube holder accessories up to Ø25mm.  
Convenient use with easily interchangeable structure.
- > **Includes microplate shaking function**  
Dedicated tray and stable speed adjustment function for optimum microplate mixing.
- > **Intuitive and convenient operation**  
Selects operation mode easily and intuitive speed control knobs.
- > **Safety features for protection of equipment**  
In case excessive pressure is applied to the top plate, operation is temporarily stopped to protect the equipment.
- > **Selectable operation mode according to application**  
Rapid vortex formation with touch mode when needed.  
Run-L/H mode provides stable continuous mixing environment.
- > **Touch mode (touch operation, Max. 3,000rpm)**  
Slip-free platform provided as standard.  
Quickly mix up to 3,000 rpm on touch.
- > **Run-L mode (continuous operation, Max. 1,500rpm)**  
Low speed mode to prevent contamination between samples.  
Stable and continuous mixing. (except for VM-T model)
- > **Run-H mode (continuous operation, Max. 3,000rpm)**  
Strong and continuous vortex formation up to 3000rpm with excellent durability.

※ Some of the above contents are limited to specific models.



Various accessories provided according to the sample.



Easy attachment and detachment.



Low-profile design and non-slip feet for stability at high speeds.

# Vortex Mixer



## True vortex mixing with innovative touch



VM-96A



VM-96T  
(Persian Blue)



VM-96T  
(Orange)



## Specification

Model		VM-96A	VM-96T	
<b>Control</b>	Speed range (rpm)	Max. 3000	Max. 3000	
	Speed control	Scale	Scale	
	Operating mode	Touch, Run-L, Run-H	Touch, Run	
	Motion	Orbital	Orbital	
	Orbit (dia., mm / inch)	4 / 0.16	4 / 0.16	
<b>Material</b>	Platform	Silicone	Silicone	
	Body	Polypropylene	Polypropylene	
	Motor type	BLDC (Brushless Direct Current)	BLDC (Brushless Direct Current)	
<b>Dimensions</b>	Platform (W x D, mm / inch)	76 x 76 / 3 x 3	76 x 76 / 3 x 3	
	Exterior (W x D x H, mm / inch)	154 x 210 x 84 / 6.1 x 8.3 x 3.3	148 x 159 x 77 / 5.8 x 6.3 x 3	
	Net weight (kg / lbs)	3.0 / 6.6	2.6 / 5.7	
<b>Protection class (DIN EN 60529)</b>		IP 42	-	
<b>Electrical requirements</b>		AC 100V to 240V, 50/60Hz		
<b>Cat. No.</b>	KR plug	AAH360215K	Persian blue	Orange
			AAH361215BK	AAH361215RK
	US plug	AAH360215U	Persian blue	Orange
			AAH361215BU	AAH361215RU

## Accessories for Vortex Mixer



Platform (pop-off)

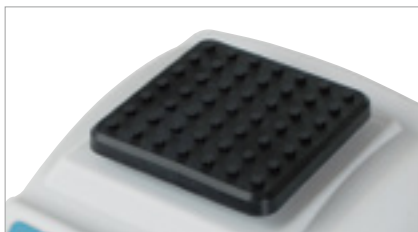

Platform (standard)  
Included as standard on equipment purchase



Microplate Tray



Cat. No.	Description
<b>00VMS0000063</b>	Platform (Pop-off)
<b>00VMS0000058</b>	Platform (standard)
<b>00VMS0000008JT</b>	Microplate tray
<b>AAA36520</b>	Tube holder (up to $\Phi 50$ mm)
<b>AAA36521</b>	Tube holder ( $\Phi 10$ mm x 16ea)
<b>AAA36522</b>	Tube holder ( $\Phi 12$ mm x 9ea)
<b>AAA36523</b>	Tube holder ( $\Phi 15$ mm x 9ea)
<b>AAA36524</b>	Tube holder ( $\Phi 20$ mm x 5ea)
<b>AAA36525</b>	Tube holder ( $\Phi 25$ mm x 4ea)
<b>AAA36526</b>	Tube holder ( $\Phi 8$ mm x 18ea & $\Phi 10$ mm x 28ea)

